



New Wave LED
by Ray Power







References

-  **NWAV S LED DIM0-10V**
-  **NWAV S LED DIMBT**

Certificates

-  **CE**
- Class I
- 120V - 277V

Wood shade colors

- Exterior**
-  26 Red
- Interior**
-  24 Yellow
- or
- Exterior**
-  30 Turquoise
- Interior**
-  24 Yellow
- or
- Exterior**
-  28 Blue
- Interior**
-  24 Yellow



Components



Metal canopy
Brushed Nickel
50 x 11,5 x 5 cm

Electrical cable
Transparent 2 m drop



Steel cable
4 x 2 m drop

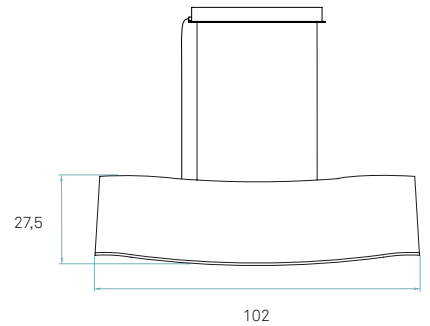

LED

 **Linear Module**
2 x 5,5 W 350mA

Energy class

A+
LED integrated
Not replaceable



Driver

MEANWELL
1 unit - Ref. LPF-16D-20
+
Bluetooth Control - CASAMBI
1 unit - Ref. CBU - ASD

Driver housed in canopy.

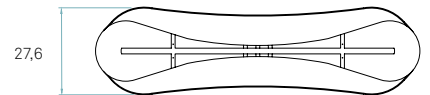

Details

Input Voltage	Luminous Flux	CRI	Watt.	CCT	Lifetime (L70)
120V-277V	691 lm	90	16 W	3000 °K	40000h

* Measurements taken using Blue exterior & Yellow interior shades, Veneer Ref: 28 Blue & 24 Yellow

