

LAB

design Karri Monni
2014











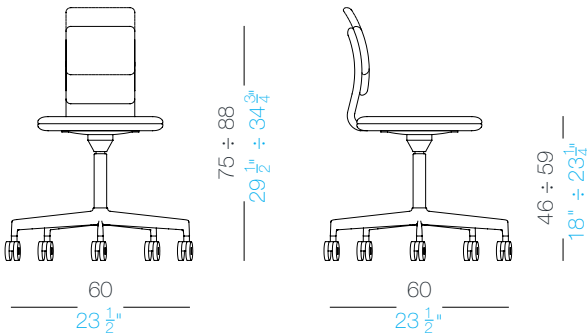





Light like a stool, yet with an anatomic and flexible back support, LAB is an office seating with a totally different look, in line with the times of contemporary work. Not the usual office chair, bulky and static, LAB gives a touch of class and colour to the working place, winking to the home working where LAB could become an iconic element thanks to its aesthetics and quality.





Stool with swivel seat and adjustable height, frame in die casting aluminium, powder coated or mat chromed, on fix feet or castors (also with auto locking). Seat in plywood with adjustable back support, upholstered in fabric, soft leather or ecoleather.



frame	upholstery	
 powder coated: black	 fabric: Hallingdal 65 18 colors	 fabric: Jet 59 colors
 powder coated: white	 fabric: Remix 2 12 colors	 fabric: Maya 43 colors
 mat chromed	 fabric: Steelcut 10 colors	 fabric: Style 28 colors
	 fabric: Divina 9 colors	
	 fabric: Cava 14 colors	 soft leather 7 colors
	 fabric: Esedra 6 colori	 eco leather

consult the portfolio for the range of colors, fabrics, soft-leather, eco-leather.

use and maintenance instructions

Clean all parts in wood, leather, fabric and metal with a damp cloth or a diluted neutral cleaner. Do not use cleaners with alcohol, bleach, solvent or abrasive products. Any liquid spilt on the product must be wiped up immediately. When lifting or moving the product, hold it on the structure and not under the seat. The product should not be subjected to unbalanced weights, as it is designed for a proper rest on the foothold (on four legs or on the base). Our company relieves from any responsibility in case of damage caused to fragile floors. Avoid any improper use of the product: do not step on the product, on the footrest or on the armrests. Avoid any movements that could compromise the proper functionality of the product or the safety of the users. Wood and leather, being natural materials, could be easily damaged. Small impurities or imperfections are within quality standard range. Do not expose the product to weather conditions or atmospheric agents, nor to heat sources over 45°C. Also products for outdoor use could be afflicted by atmospheric agents. The product could undergo possible exterior changes due to particular exposure to heat, humidity and saltiness. An appropriate and frequent maintenance and cleaning of the product enhances its durability. The product could change colour and shade, if exposed to direct sunlight. Maintenance has to be carried out by experienced staff. Dispose of the package only after assembling the product, in order to avoid the loss of ironmongery and components. Once the product has been dismantled, the product itself or its components must be given to the public garbage disposal system, according to the legislation in force.