



MEDIUM SUSPENSION / **Cuad LED**
by Burkhard Dämmer









References

-  CUAD SM LED DIM0-10V
-  CUAD SM LED DIMBT

Certificates

-  Class I
- 120V - 277V

Wood shade colors

-  20 Ivory White
-  21 Natural Cherry
-  22 Natural Beech
-  24 Yellow
-  25 Orange
-  26 Red
-  28 Blue
-  29 Grey
-  30 Turquoise
-  31 Chocolate



Components



Top diffuser
Black or White

The standard top diffuser is white. Black is also available if you want no upward light diffusion.

Bottom diffuser
Matt satin acrylic



Metal canopy
Brushed Nickel
50 x 11,5 x 5 cm

Electrical cable
Transparent 2 m drop



Steel cable
4 x 2 m drop

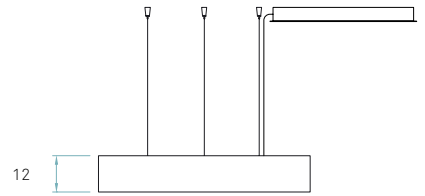

LED

 Linear Module
8 x 5,5 W 350mA

Energy class

A+
LED integrated
Not replaceable



Driver

MEANWELL
1 unit - Ref. NPF 60D-42
+
Bluetooth Control - CASAMBI
1 unit - Ref. CBU - ASD

Driver housed in canopy.

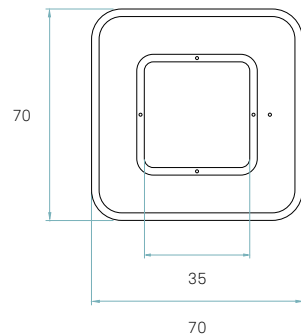

Details

Input Voltage	Luminous Flux *	CRI	Watt.	CCT	Lifetime (L70)
120V-277V	3687 lm	90	50 W	3000 °K	40000h

* Measurements taken using white shades, Veneer Ref: 20 Ivory White

